



Project: _____

Catalog#: _____

Notes: _____

Date: _____

Type: _____

1'x4'/2'x2'/2'x4' EDGE-LIT LED FLAT PANEL



APPLICATIONS

- SHOPPING CENTERS
- AIRPORTS
- HOSPITALITY
- OFFICE BUILDINGS
- LIBRARIES
- FAST FOOD RESTAURANTS
- SCHOOLS
- CORRIDOR
- CHURCHES
- HALLWAY
- HEALTHCARE
- OTHER INDOOR APPLICATIONS



KEY FEATURES

CONSTRUCTION

Ultra Thin Lighting Surface with steel backing wrapped in an aluminum frame for heat dissipation. Great for compact areas. Suitable for damp location.

OPTICAL SYSTEM

Heat resistant frosted acrylic lens diffuser. Superior light distribution that is even & glare-free.

CERTIFICATION

ETL and DLC FCC listed; with LM79 & LM80

ELECTRICAL

1X4 Luminaire is available in: 36W

2x2 Luminaire is available in: 30W & 36W

2X4 Luminaire is available in: 48W & 60W

High lumen efficacy 130lm/w, 0-10V dimming, Isolated Driver

INSTALLATION

Easy installation. Standard grid ceiling lay-in mount.

Suspension Mount and Surface mount is optional.

Flicker free. CCT: 3500K & 4000K & 5000K.

WARRANTY

Industry leading Five (5) year manufacturer warranty in the USA.

ORDERING

MODEL NUMBER(S)

MODEL NUMBER	POWER	LUMENS PER WATT	LUMENS	Length	COLOR TEMPERATURE	CRI	LIFE HOURS
DM-P71436W	36 Watts	130	4,680	1 X 4 FT	4000K, 5000K	>0.9	50,000
DM-P72230W	30 Watts	130	3,900	2 X 2 FT	4000K, 5000K	>0.9	50,000
DM-P72236W	36 Watts	130	4,680	2 X 2 FT	3500K, 4000K, 5000K	>0.9	50,000
DM-P72448W	48 Watts	130	6,240	2 X 4 FT	4000K, 5000K	>0.9	50,000
DM-P72460W	60 Watts	130	7,800	2 X 4 FT	4000K, 5000K	>0.9	50,000

1' X 4' 36W EDGE-LIT LED FLAT PANEL Series

PERFORMANCE DATA

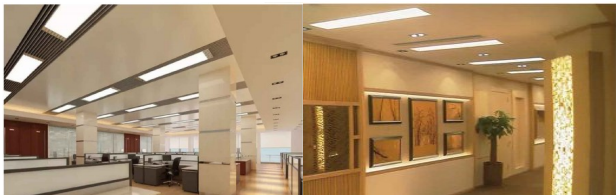

ACCESSORIES



DIMENSIONS

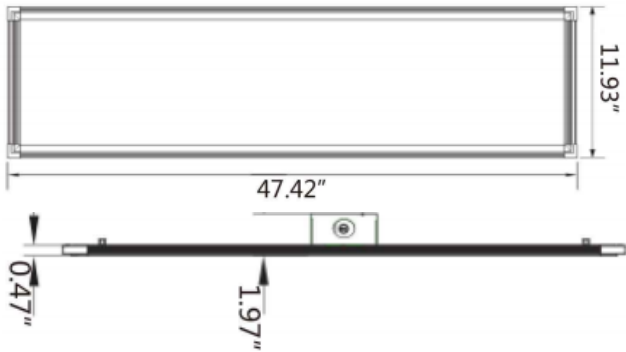

PHOTOMETRIC DATA

LUMINOUS INTENSITY DISTRIBUTION DIAGRAM

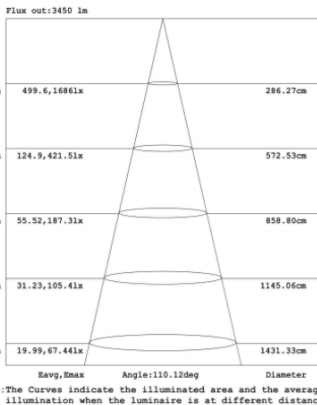
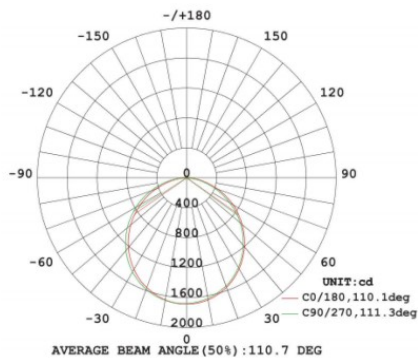

MODEL TECHNICAL SUMMARY

DM-P71436W

INPUT WATTS	36 Watts
INPUT VOLTAGE	AC 120-277V
POWER FREQUENCY	50 / 60 HZ
EFFICACY	130 lm/W
LED CHIPS	SAMSUNG LEDS
LED DRIVER	CONSTANT POWER
DELIVERED LUMENS	4,680 LM
COLOR TEMPERATURE	4000K / 5000K
CRI	RA>80
WORKING TEMPERATURE	-30°C - +45°C
STORAGE TEMPERATURE	-30°C - +60°C
IP RATING	IP20
CERTIFICATION	ETL CE FCC DLC Premium
WARRANTY TIME	5 Years
OPTIONAL ACCESSORY	EM Backup/ Occupancy Sensor / Suspension / Surface Mount
DIMMABLE	0-10V Dimmable
BEAM ANGLE	120°
THD	<20%
POWER FACTOR	>0.9
L70 (HOURS)	50,000
DIMENSIONS (L*W*H) INCHES	47.4" * 11.9" * 0.47"

DLC PREMIUM LISTING

Model: DM-P71436W-40K-ZZ

Manufacturer: Shenzhen DM Lighting Co., LTD
Brand: DM-Light
Technical Requirements Version: 4.4
Data Qualified: 01/15/2017
Product ID: PH071279

Classification
Main: Indoor Luminaires
General Application: Traffic
Primary Use: Not Suitable for Ambient Lighting of Interior
Control of Space: -
System Type: -AC
Classification: Premium
In Patent Product: No
DLC Family Code: 05271V
Listing Status: Listed

Reported Data | Zonal Lumens | Spacing Criteria | Product Features | Version History | Family Data

Light Output: 4762.3 lm
Wattage: 35.1 (500 Invt)
Efficacy (lm/W): 134.25
Power Factor: 0.93
CRI: 81.94
CCT: 4000K
Total Harmonic Distortion: 16.7%

Model: DM-P71436W-50K-ZZ

Manufacturer: Shenzhen DM Lighting Co., LTD
Brand: DM-Light
Technical Requirements Version: 4.4
Data Qualified: 01/15/2017
Product ID: PH071279

Classification
Main: Indoor Luminaires
General Application: Traffic
Primary Use: Not Suitable for Ambient Lighting of Interior
Control of Space: -
System Type: -AC
Classification: Premium
In Patent Product: No
DLC Family Code: 05271V
Listing Status: Listed

Reported Data | Zonal Lumens | Spacing Criteria | Product Features | Version History | Family Data

Light Output: 4860.34 lm
Wattage: 35.2 (500 Invt)
Efficacy (lm/W): 138.08
Power Factor: 0.93
CRI: 81.94
Total Harmonic Distortion: 17.1%

2' X 2' 30W EDGE-LIT LED FLAT PANEL Series

PERFORMANCE DATA



ACCESSORIES



DIMENSIONS

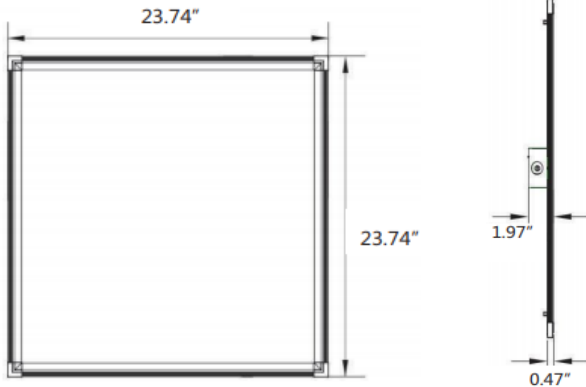

PHOTOMETRIC DATA

LUMINOUS INTENSITY DISTRIBUTION DIAGRAM

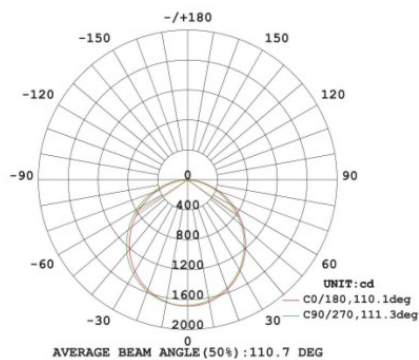

Flux out: 3450 lm

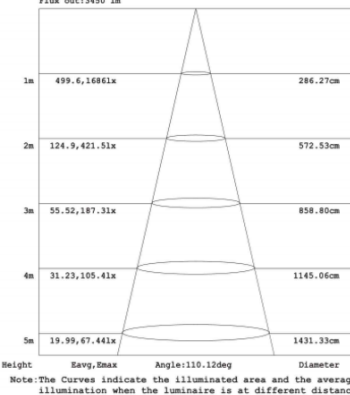

MODEL TECHNICAL SUMMARY

DM-P72230W

INPUT WATTS	30 Watts
INPUT VOLTAGE	AC 120-277V
POWER FREQUENCY	50 / 60 HZ
EFFICACY	130 lm/W
LED CHIPS	SAMSUNG LEDS
LED DRIVER	CONSTANT POWER
DELIVERED LUMENS	3,900 LM
COLOR TEMPERATURE	3500K / 4000K / 5000K
CRI	RA>80
WORKING TEMPERATURE	-30°C - +45°C
STORAGE TEMPERATURE	-30°C - +60°C
IP RATING	IP20
CERTIFICATION	ETL CE FCC DLC Premium
WARRANTY TIME	5 Years
OPTIONAL ACCESSORY	EM Backup/ Occupancy Sensor / Suspension / Surface Mount
DIMMABLE	0-10V Dimmable
BEAM ANGLE	120°
THD	<20%
POWER FACTOR	>0.9
L70 (HOURS)	50,000
DIMENSIONS (L*W*H) INCHES	23.7" * 23.7" * 0.47"

DLC PREMIUM LISTING

Model: DM-P72230W-40K-AZ			
Manufacturer: Shenzhen Deyi Lighting Co., LTD			
Brand: Deyi Light			
Technical Requirements Version: 4.4			
Data Qualified: 05/22/2018			
Product ID: 61648696952			
Classification			
Material: Indoor Luminaire	General Application: Troffer	Classification: Premium	View Notes
Primary Color: 353 Luminaire for Ambient Lighting of Interior	Connective System: AC	DLC Family Code: 2422ZY	View Notes
System Type: AC		Listing Status: Listed	
Reported Data			
Light Output: 3728.1 lm	Zone Lumens	Spacing Criteria	Product Features
Wattage: 30.0 W	Version History	Family Data	
Efficiency (lm/W): 124.27 lm/W			
Power Factor: 0.92			
CRI: 80.0			
Total Harmonic Distortion: 14.5%			
Model: DM-P72230W-50K-AZ			
Manufacturer: Shenzhen Deyi Lighting Co., LTD			
Brand: Deyi Light			
Technical Requirements Version: 4.4			
Data Qualified: 05/22/2018			
Product ID: 616487181820			
Classification			
Material: Indoor Luminaire	General Application: Troffer	Classification: Premium	View Notes
Primary Color: 353 Luminaire for Ambient Lighting of Interior	Connective System: AC	DLC Family Code: 2422ZY	View Notes
System Type: AC		Listing Status: Listed	
Reported Data			
Light Output: 3885.0 lm	Zone Lumens	Spacing Criteria	Product Features
Wattage: 30.0 W	Version History	Family Data	
Efficiency (lm/W): 129.50 lm/W			
Power Factor: 0.92			
CRI: 80.0			
Total Harmonic Distortion: 16.6%			

2' X 2' 36W EDGE-LIT LED FLAT PANEL Series

PERFORMANCE DATA



ACCESSORIES



DIMENSIONS

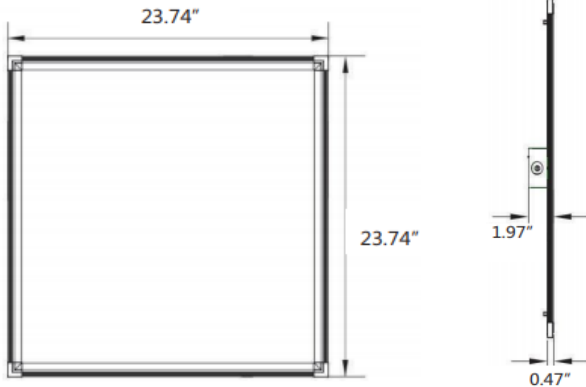

PHOTOMETRIC DATA

LUMINOUS INTENSITY DISTRIBUTION DIAGRAM

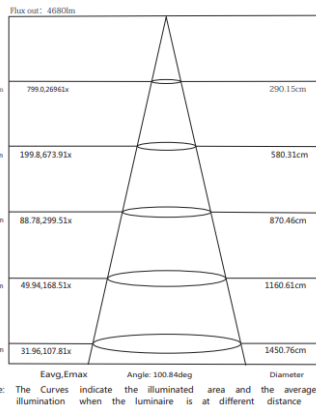
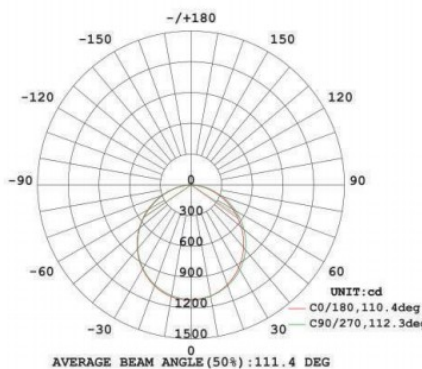

MODEL TECHNICAL SUMMARY

DM-P72236W

INPUT WATTS	36 Watts
INPUT VOLTAGE	AC 120-277V
POWER FREQUENCY	50 / 60 HZ
EFFICACY	130 lm/W
LED CHIPS	SAMSUNG LEDS
LED DRIVER	CONSTANT POWER
DELIVERED LUMENS	4,680 LM
COLOR TEMPERATURE	3500K / 4000K / 5000K
CRI	RA>80
WORKING TEMPERATURE	-30°C - +45°C
STORAGE TEMPERATURE	-30°C - +60°C
IP RATING	IP20
CERTIFICATION	ETL CE FCC DLC Premium
WARRANTY TIME	5 Years
OPTIONAL ACCESSORY	EM Backup/ Occupancy Sensor / Suspension / Surface Mount
DIMMABLE	0-10V Dimmable
BEAM ANGLE	120°
THD	<20%
POWER FACTOR	>0.9
L70 (HOURS)	50,000
DIMENSIONS (L*W*H) INCHES	23.7" * 23.7" * 0.47"

DLC PREMIUM LISTING

<p>DM-P72236W-36W-02</p> <p>Manufacturer: Acuity-Lighting Co., Inc. Model: DM-P72236W-36W-02 Part Number: DM-P72236W-36W-02 Description: 2' x 2' Edge-Lit LED Flat Panel, 36W, 120-277V, 50/60Hz, 130lm/W, RA>80, 50000h L70, 0-10V Dimmable, IP20, ETL, CE, FCC, DLC Premium</p>	<p>DM-P72236W-40W-02</p> <p>Manufacturer: Acuity-Lighting Co., Inc. Model: DM-P72236W-40W-02 Part Number: DM-P72236W-40W-02 Description: 2' x 2' Edge-Lit LED Flat Panel, 40W, 120-277V, 50/60Hz, 130lm/W, RA>80, 50000h L70, 0-10V Dimmable, IP20, ETL, CE, FCC, DLC Premium</p>
<p>DM-P72236W-48W-02</p> <p>Manufacturer: Acuity-Lighting Co., Inc. Model: DM-P72236W-48W-02 Part Number: DM-P72236W-48W-02 Description: 2' x 2' Edge-Lit LED Flat Panel, 48W, 120-277V, 50/60Hz, 130lm/W, RA>80, 50000h L70, 0-10V Dimmable, IP20, ETL, CE, FCC, DLC Premium</p>	<p>DM-P72236W-60W-02</p> <p>Manufacturer: Acuity-Lighting Co., Inc. Model: DM-P72236W-60W-02 Part Number: DM-P72236W-60W-02 Description: 2' x 2' Edge-Lit LED Flat Panel, 60W, 120-277V, 50/60Hz, 130lm/W, RA>80, 50000h L70, 0-10V Dimmable, IP20, ETL, CE, FCC, DLC Premium</p>

2' X 4' 48W EDGE-LIT LED FLAT PANEL Series

PERFORMANCE DATA



ACCESSORIES



DIMENSIONS

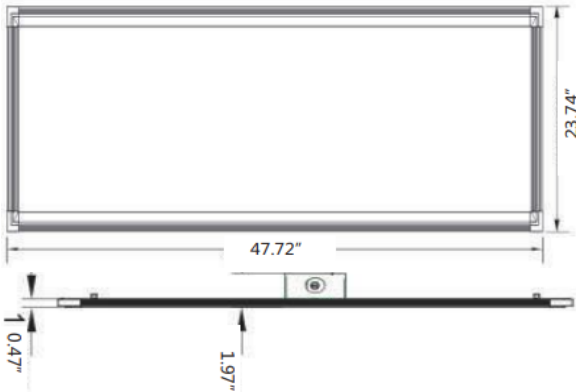

PHOTOMETRIC DATA

LUMINOUS INTENSITY DISTRIBUTION DIAGRAM

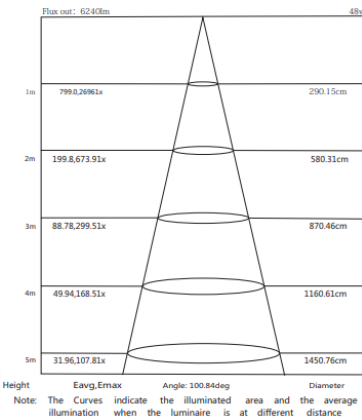
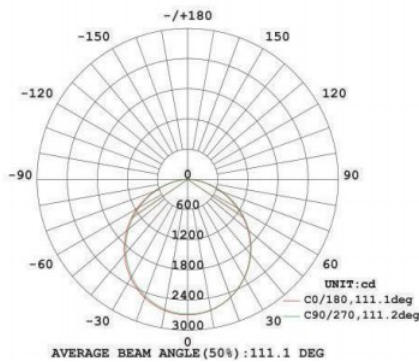

MODEL TECHNICAL SUMMARY

DM-P72448W

INPUT WATTS	48 Watts
INPUT VOLTAGE	AC 120-277V
POWER FREQUENCY	50 / 60 HZ
EFFICACY	130 lm/W
LED CHIPS	SAMSUNG LEDS
LED DRIVER	CONSTANT POWER
DELIVERED LUMENS	6,240 LM
COLOR TEMPERATURE	4000K / 5000K
CRI	RA>80
WORKING TEMPERATURE	-30°C - +45°C
STORAGE TEMPERATURE	-30°C - +60°C
IP RATING	IP20
CERTIFICATION	ETL CE FCC DLC Premium
WARRANTY TIME	5 Years
OPTIONAL ACCESSORY	EM Backup/ Occupancy Sensor / Suspension / Surface Mount
DIMMABLE	0-10V Dimmable
BEAM ANGLE	120°
THD	<20%
POWER FACTOR	>0.9
L70 (HOURS)	50,000
DIMENSIONS (L*W*H) INCHES	47.7" * 23.7" * 0.47"

DLC PREMIUM LISTING

Model: DM-P72448W-48K-CZ			
Manufacturer: Shenzhen Dim Lighting Co., LTD			
Brand: DM-LIGHT			
Technical Requirements Version: 4.4			
Date Qualified: 01/10/2017			
Product ID: P32J200V			
Classification			
Main: Indoor Luminaire	Classification: Premium	View	
General Application: Troffer	DA Project Product: No	Notes	
Primary Use: 2x4 Luminaire for Ambient Lighting of Interior	DLC Family Code: 020717		
Common Application:	DLC Family Code: 020717		
System Type: AC	Listing Status: Listed		
Reported Data			
Zonal Lumens			
Spacing Criteria			
Product Features			
Version History			
Family Data			
Light Output: 6240 lm			
Wattage: 48 W			
Efficiency (lm/W): 130.0000			
Power Factor: 0.97			
CFL: 0.0000			
CRI: 82			
Total Beamwise Distribution: 14.3%			
Model: DM-P72448W-50K-CZ			
Manufacturer: Shenzhen Dim Lighting Co., LTD			
Brand: DM-LIGHT			
Technical Requirements Version: 4.4			
Date Qualified: 01/10/2017			
Product ID: P32J200W			
Classification			
Main: Indoor Luminaire	Classification: Premium	View	
General Application: Troffer	DA Project Product: No	Notes	
Primary Use: 2x4 Luminaire for Ambient Lighting of Interior	DLC Family Code: 020717		
Common Application:	DLC Family Code: 020717		
System Type: AC	Listing Status: Listed		
Reported Data			
Zonal Lumens			
Spacing Criteria			
Product Features			
Version History			
Family Data			
Light Output: 6240 lm			
Wattage: 48 W			
Efficiency (lm/W): 130.0000			
Power Factor: 0.93			
CFL: 0.0000			
CRI: 82			
Total Beamwise Distribution: 14.3%			

2' X 4' 60W EDGE-LIT LED FLAT PANEL Series

PERFORMANCE DATA



ACCESSORIES



DIMENSIONS

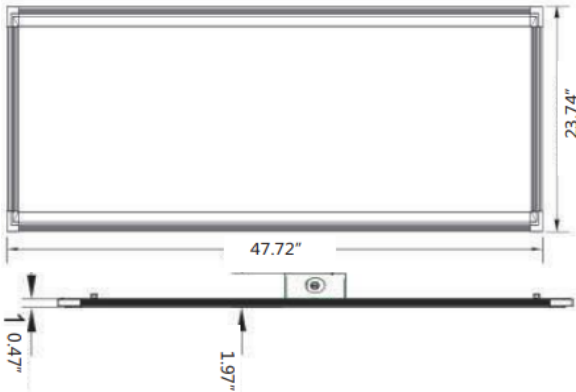

PHOTOMETRIC DATA

LUMINOUS INTENSITY DISTRIBUTION DIAGRAM

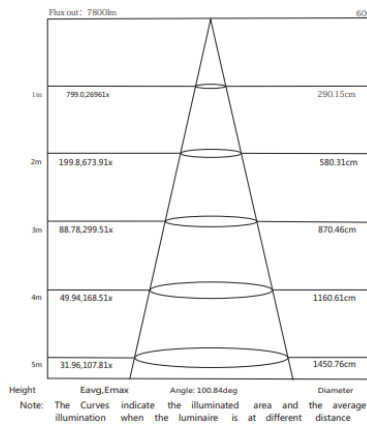
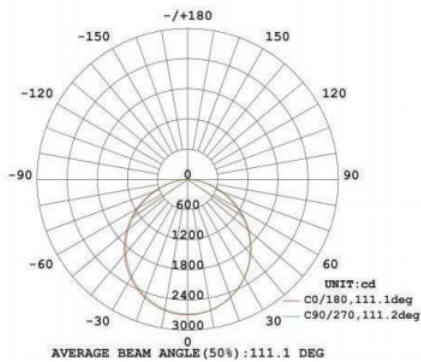

MODEL TECHNICAL SUMMARY

DM-P72460W

INPUT WATTS	60 Watts
INPUT VOLTAGE	AC 120-277V
POWER FREQUENCY	50 / 60 HZ
EFFICACY	130 lm/W
LED CHIPS	SAMSUNG LEDS
LED DRIVER	CONSTANT POWER
DELIVERED LUMENS	7,800 LM
COLOR TEMPERATURE	4000K / 5000K
CRI	RA>80
WORKING TEMPERATURE	-30°C - +45°C
STORAGE TEMPERATURE	-30°C - +60°C
IP RATING	IP20
CERTIFICATION	ETL CE FCC DLC Premium
WARRANTY TIME	5 Years
OPTIONAL ACCESSORY	EM Backup/ Occupancy Sensor / Suspension / Surface Mount
DIMMABLE	0-10V Dimmable
BEAM ANGLE	120°
THD	<20%
POWER FACTOR	>0.9
L70 (HOURS)	50,000
DIMENSIONS (L*W*H) INCHES	47.7" * 23.7" * 0.47"

DLC PREMIUM LISTING

Model: DM-P72460W-40K-ZZ			
Manufacturer: Shenzhen Omi Lighting Co., LTD			
Brand: Omi-Light			
Technical Requirements Version: 4.4			
Data Qualified: 06/01/2017			
Product ID: P72460W-ZZ			
Classification		Premium	
Make: In-house Luminaire		In-Plant Product: Yes	
General Application: Traffic		DLC Family Code: P72460W	
Primary Use: 24 Luminaire for Ambient Lighting of Interior		Listing Status: Listed	
System Type: AC			
Reported Data	Zonal Lumens	Spacing Criteria	Product Features
Light Output: 7800 lm			
Wattage: 60 W			
Efficiency (lm/W): 130 lm/W			
Power Factor: 0.98			
THD: <20%			
CRI: 82			
Total Harmonic Distortion: 12.3%			
Model: DM-P72460W-50K-ZZ			
Manufacturer: Shenzhen Omi Lighting Co., LTD			
Brand: Omi-Light			
Technical Requirements Version: 4.4			
Data Qualified: 06/01/2017			
Product ID: P72460W-ZZ			
Classification		Premium	
Make: In-house Luminaire		In-Plant Product: Yes	
General Application: Traffic		DLC Family Code: P72460W	
Primary Use: 24 Luminaire for Ambient Lighting of Interior		Listing Status: Listed	
System Type: AC			
Reported Data	Zonal Lumens	Spacing Criteria	Product Features
Light Output: 7800 lm			
Wattage: 60 W			
Efficiency (lm/W): 130 lm/W			
Power Factor: 0.98			
THD: <20%			
CRI: 82			
Total Harmonic Distortion: 12.3%			